

①
Lid
x1

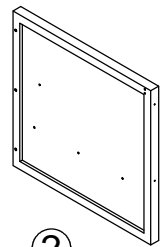

②
Left Side Plank
x1

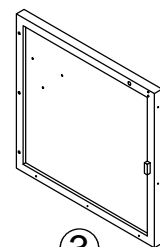

③
Right Side Plank
x1

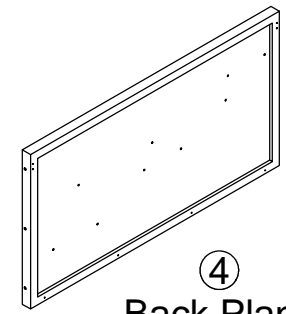

④
Back Plank
x1

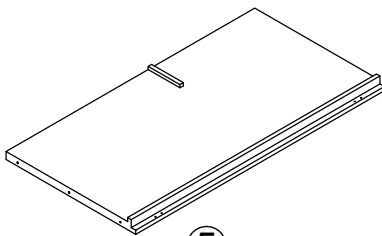

⑤
Bottom Plank
x1

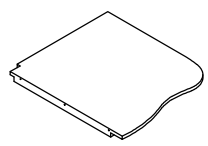

⑥
Layer Plank
x1



⑦
Layer Plank
x1

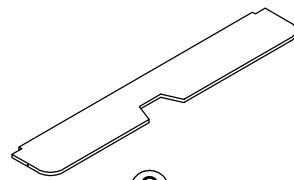

⑧
Layer Plank
x1



⑨
Layer Plank
x1



⑩
Stair
x1

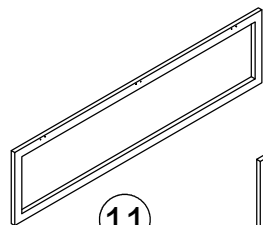

⑪
Front Lid
x1

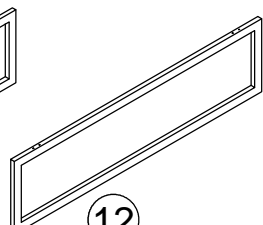

⑫
Front Plank
x1

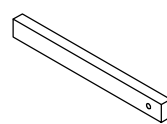

⑬
Support Bar
x2



⑭
Stopper
x4



⑮
x2

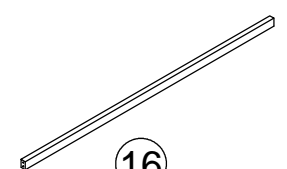

⑯
x1



A
x6 pcs



B
x26 pcs



C
x8 pcs

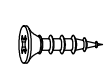

D
x24 pcs

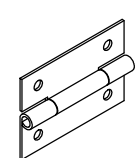

E
x2 pcs

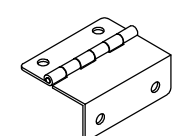

F
x4 pcs

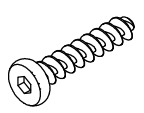

G
x2 pcs

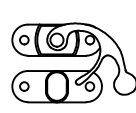

H
x3 pcs



I
x12 pcs



J
x4 pcs



K
x6 pcs

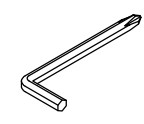

L
x1 pc

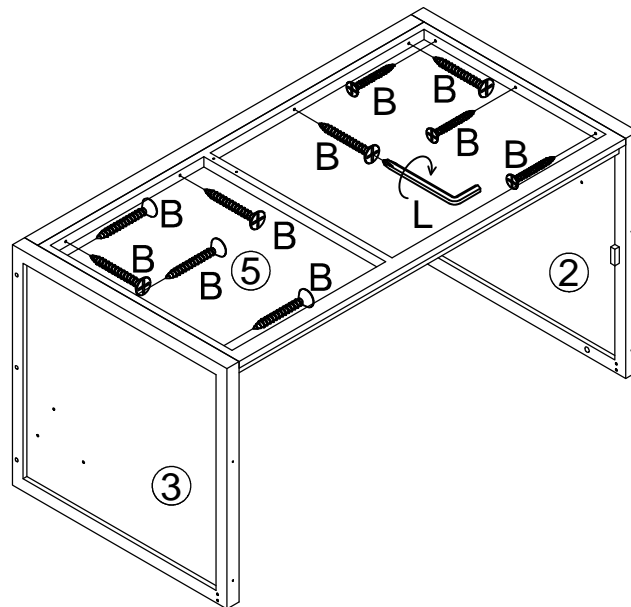
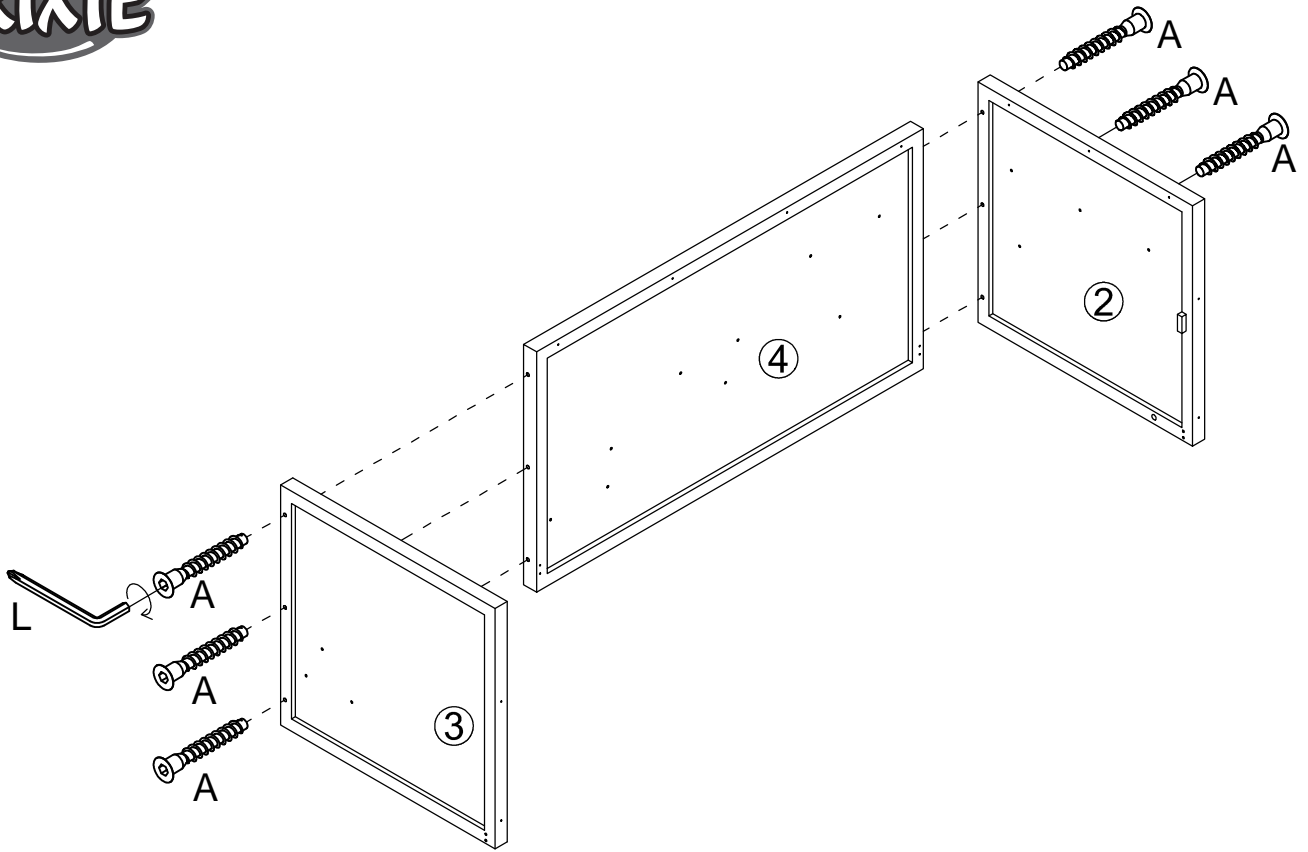

TRIXIE

